



# INSTALLATION INSTRUCTIONS

Accessory

**AIR DEFLECTOR  
P/N 08P47-SJC-100**

Application

**2012 RIDGELINE**

Publications No.

**All 12004**

Issue Date

**NOV 2010**

## PARTS LIST

Air deflector

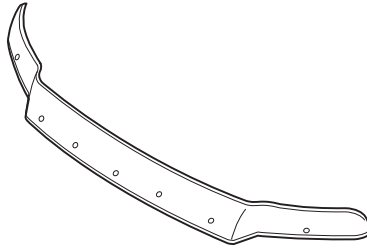

Center bracket

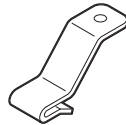

2 Front brackets A

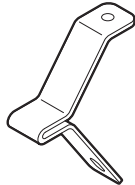

2 Front brackets B

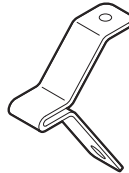

2 Side brackets

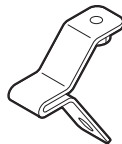

6 Plastic grommets



6 Screws, 5 x 13 mm



2 Screws, 6 x 11 mm



7 Protective tapes



2 Alcohol pads

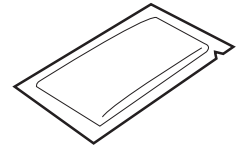

5 Clips A



4 Clips B



2 Collars



Center stop

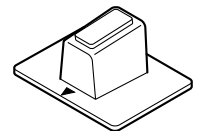

## TOOLS AND SUPPLIES REQUIRED

#2 Phillips screwdriver

Tape measure

Felt-tip pen

Shop towel

Masking tape

Clip remover

## INSTALLATION

**Customer Information:** The information in this installation instruction is intended for use only by skilled technicians who have the proper tools, equipment, and training to correctly and safely add equipment to your vehicle. These procedures should not be attempted by “do-it-yourselfers.”

### NOTE:

- Be careful not to damage the body finish when you install the air deflector.
  - This air deflector should be installed only when the ambient air temperature is above 60°F (15°C).
1. Using the front “H” emblem, locate the center of the hood. From the bottom of the hood, measure up 2 in. (52 mm), and use an alcohol pad to clean the area where the center stop will attach.

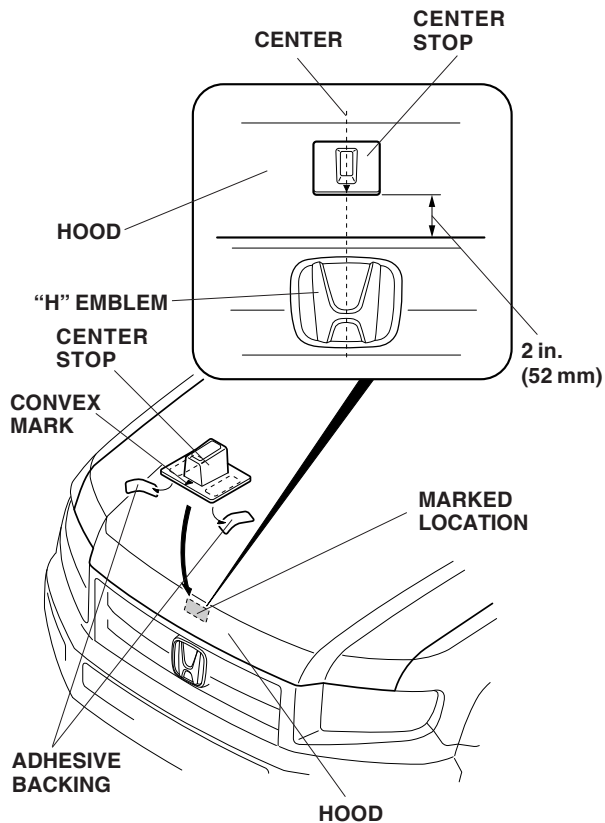

2. Remove the adhesive backing from the center stop, and attach it to the hood at the marked location with the convex mark facing down.

3. Open the hood. Locate the outer four clips that attach the rubber molding. Remove the four clips from the rubber molding.

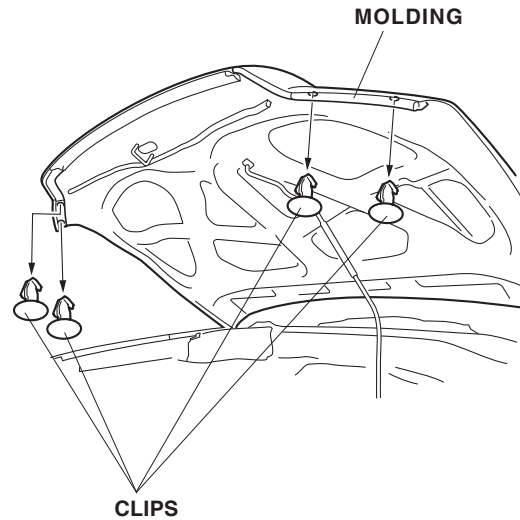

4. Pull back the rubber molding and locate the six square holes in the hood. Push one plastic grommet into each square hole.

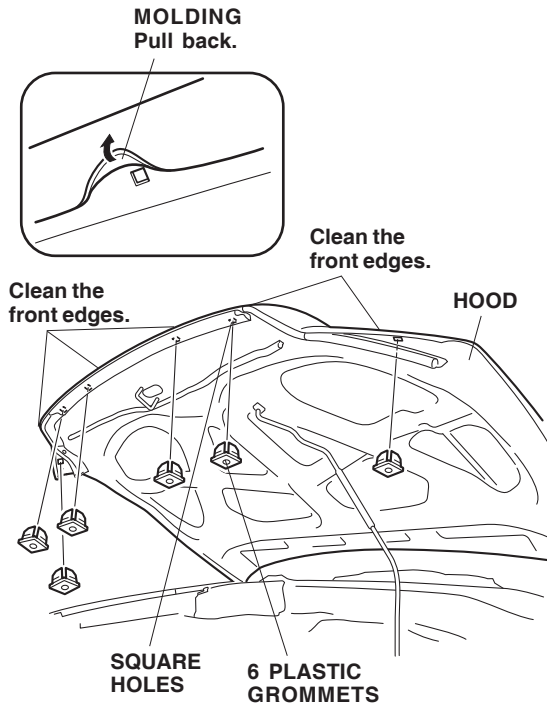

5. Clean the front edge of the hood with the other alcohol pad from the kit.

- Slide the front brackets A and B and the side brackets over the lip of the hood. Align the hole in each bracket with the hole in the plastic grommet.

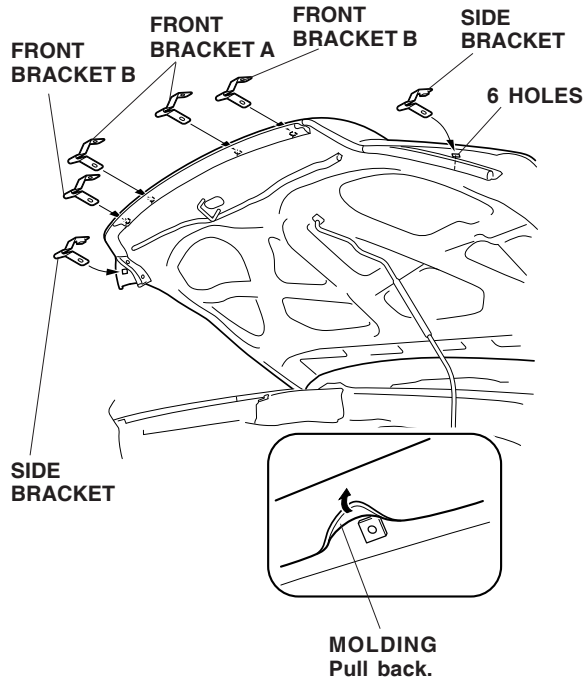

- Attach a piece of masking tape to the hood under each bracket.

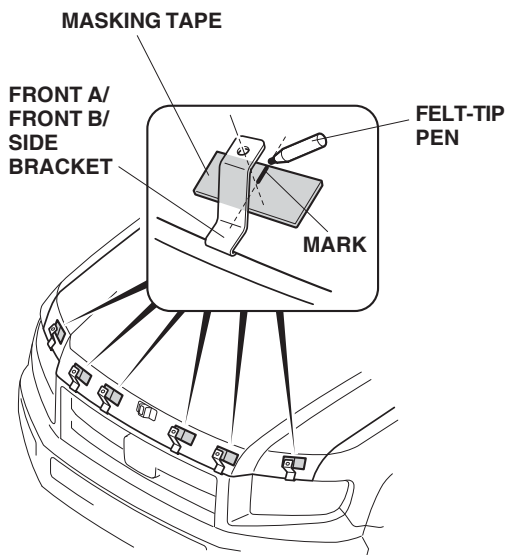

- Using a felt-tip pen, mark the masking tape at the center of each bracket. Remove all of the brackets from the hood.

- Attach six protective tapes around the front edge of the hood at the six marked locations.

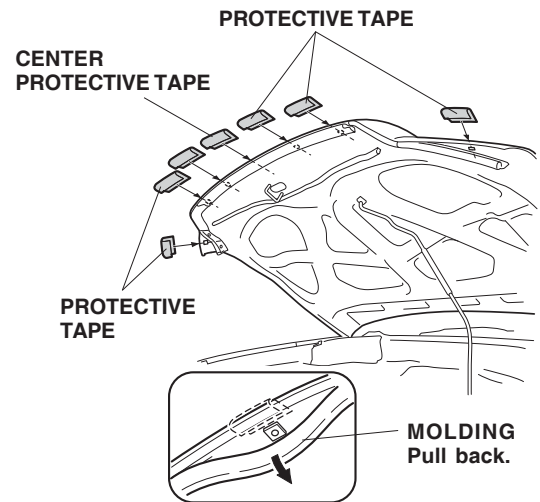

- Attach the remaining protective tape around the center of the front edge of the hood. Remove the masking tape.

11. Reinstall the two front brackets A, two front brackets B, and two side brackets over the hood around the protective tapes, and install the 5 x 13 mm screws. Push each bracket against the hood while you install the screw. Do not tighten the six 5 x 13 mm screws at this time.

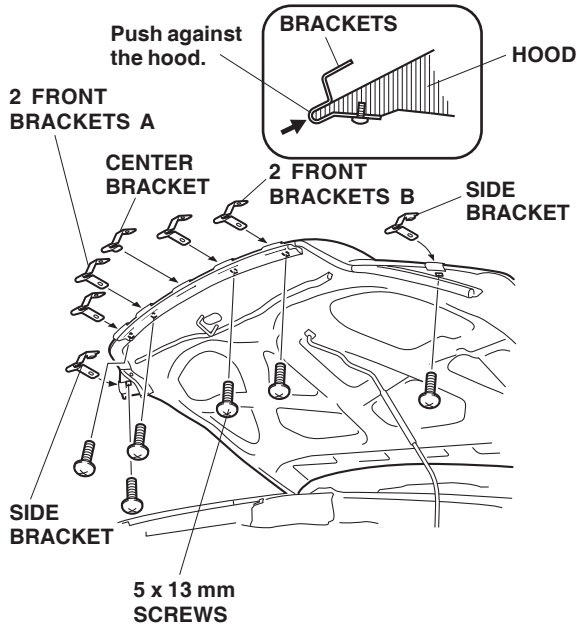

12. Install the center bracket over the hood around the protective tape.

13. Close the hood. Position the air deflector on the hood, and attach the air deflector to the two front brackets A, two front brackets B and center bracket using the five clips A.

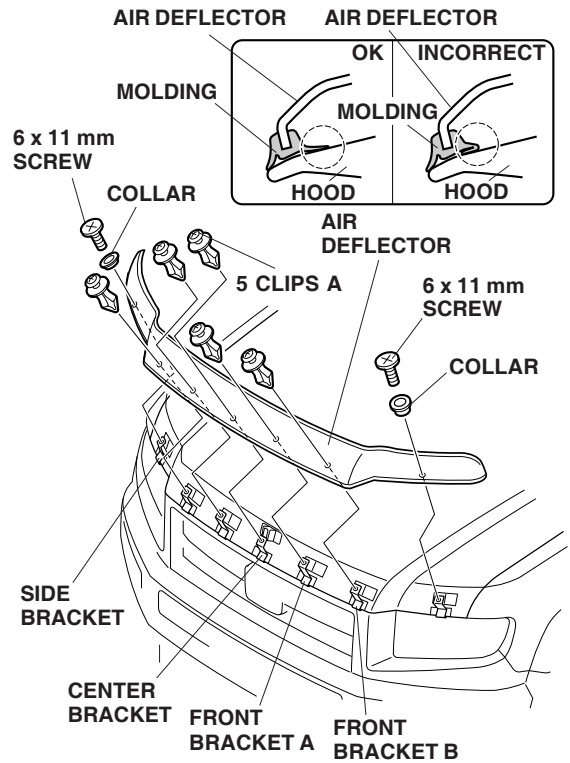

Make sure the edge of the molding is flat and not tucked under.

14. Align the holes in the air deflector over the two side brackets, and install the two 6 x 11 mm screws and two collars. Tighten the screws securely.
15. Open the hood, and tighten the six 5 x 13 mm screws you installed in step 11.
16. Install the four clips B to secure the rubber molding.

